



SSC8039GQ4

P-Channel Enhancement Mode MOSFET

➤ **Features**

VDS	VGS	RDSON Typ.	ID
-30V	±20V	12mR@-10V	-27A
		15mR@-4V5	

➤ **Pin configuration**

Top view

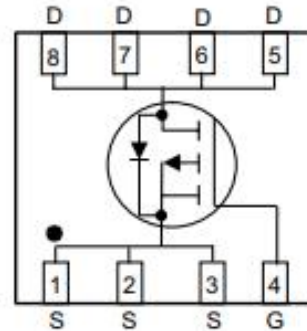

➤ **Description**

This device is produced with high cell density DMOS trench technology, which is especially used to minimize on-state resistance. This device is particularly suited for low voltage power management requiring a wide range of given voltage ratings(4.5V~18V) such as load switch and battery protection.



Bottom View

➤ **Applications**

- Load Switch
- NB battery
- DCDC conversion

➤ **Ordering Information**

Device	Package	Shipping
SSC8039GQ4	DFN3x3	5000/Reel

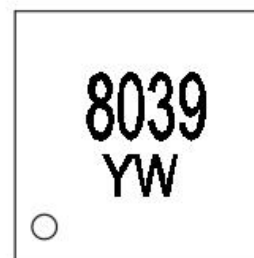

(Y: year/W: week)

Marking

➤ **Absolute Maximum Ratings**($T_A=25^{\circ}\text{C}$ unless otherwise noted)

Symbol	Parameter		Ratings	Unit
V_{DSS}	Drain-to-Source Voltage		-30	V
V_{GSS}	Gate-to-Source Voltage		± 20	V
I_D	Continuous Drain Current	$TC=25^{\circ}\text{C}$	-27	A
		$TC=100^{\circ}\text{C}$	-16	
I_{DSM}	Continuous Drain Current ^a	$TA=25^{\circ}\text{C}$	-10.5	A
		$TA=70^{\circ}\text{C}$	-8.3	
I_{DM}	Pulsed Drain Current ^b		-79	A
E_{AS}	Avalanche Energy $L=0.1\text{mH}$		29	mJ
P_D	Power Dissipation ^c	$TC=25^{\circ}\text{C}$	25	W
		$TC=100^{\circ}\text{C}$	9.5	W
P_{DSM}	Power Dissipation ^a	$TA=25^{\circ}\text{C}$	3.3	W
		$TA=70^{\circ}\text{C}$	2.2	W
$T_J T_{STG}$	Storage and Operation junction temperature		-55 to 150	$^{\circ}\text{C}$

➤ **Thermal Resistance Ratings**($T_A=25^{\circ}\text{C}$ unless otherwise noted)

Symbol	Parameter	Typical	Maximum	Unit
$R_{\theta JA}$	Junction-to-Ambient Thermal Resistance ^a		40	$^{\circ}\text{C}/\text{W}$
$R_{\theta JC}$	Junction-to-Case Thermal Resistance		6	

Note:

- The value of $R_{\theta JA}$ is measured with the device mounted on 1 in² FR-4 board with 2oz.copper, in a still air environment with $T_A=25^{\circ}\text{C}$. The value in any given application depends on the user is specific board design. The current rating is based on the $t \leq 10\text{s}$ thermal resistance rating.
- Repetitive rating, pulse width limited by junction temperature.
- The power dissipation P_D is based on $T_J(\text{MAX})=150^{\circ}\text{C}$, using junction-to-case thermal resistance, and is more useful in setting the upper dissipation limit for cases where additional heat sinking is used.



➤ **Electronics Characteristics**($T_A=25^{\circ}\text{C}$ unless otherwise noted)

Symbol	Parameter	Test Conditions	Min	Typ.	Max	Unit
$V_{(BR)DSS}$	Drain-Source Breakdown Voltage	$V_{GS}=0V, I_D=-250\mu A$	-30			V
$V_{GS(th)}$	Gate Threshold Voltage	$V_{DS}=V_{GS}, I_D=-250\mu A$	-1	-1.3	-3	V
$R_{DS(on)}$	Drain-Source On-Resistance	$V_{GS}=-10V, I_D=-10A$		12	16	mR
		$V_{GS}=-4.5V, I_D=-7A$		15	20	
I_{DSS}	Zero Gate Voltage Drain Current	$V_{DS}=-30V, V_{GS}=0V$			-1	μA
I_{GSS}	Gate-Source leak current	$V_{GS}=\pm 20V, V_{DS}=0V$			± 100	nA
G_{FS}	Transconductance	$V_{DS}=-5V, I_D=-10A$		18		S
V_{SD}	Forward Voltage	$V_{GS}=0V, I_S=-1A$		-0.75	-1.6	V
C_{iss}	Input Capacitance	$V_{DS}=-20V, V_{GS}=0V,$ $f=1MHz$		2000		pF
C_{oss}	Output Capacitance			550		
C_{rss}	Reverse Transfer Capacitance			800		
Q_g	Total Gate charge	$V_{GS}=-4.5V, V_{DS}=-15V,$ $I_D=-7A$		14		nC
Q_{gs}	Gate to Source charge			4.4		
Q_{gd}	Gate to Drain charge			2.7		
$T_{D(ON)}$	Turn-on delay time	$V_{GS}=-10V,$ $V_{DS}=-15V, R_L=1.5R,$ $R_G=3R$		8.6		ns
T_r	Rise time			6		
$T_{D(OFF)}$	Turn-off delay time			39		
T_f	Fall time			15		



➤ **Typical Characteristics** ($T_A=25^\circ\text{C}$ unless otherwise noted)

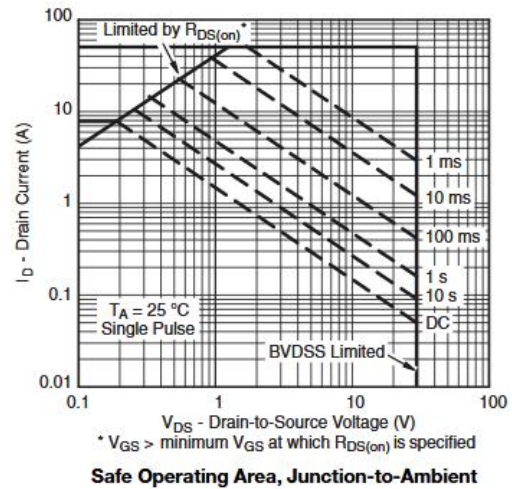
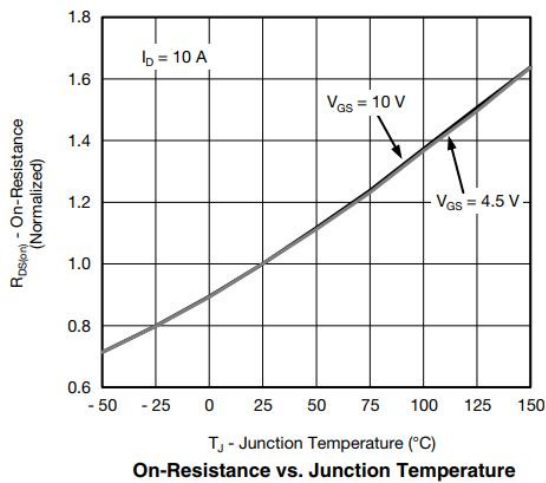
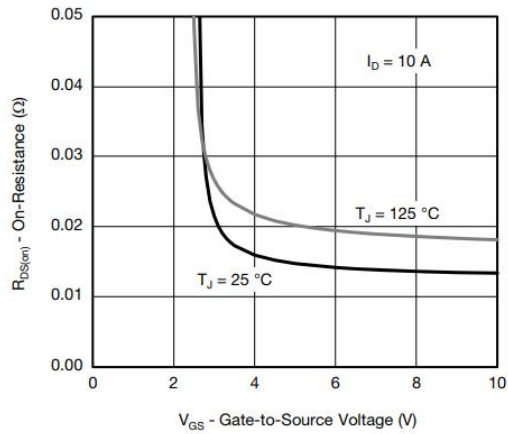
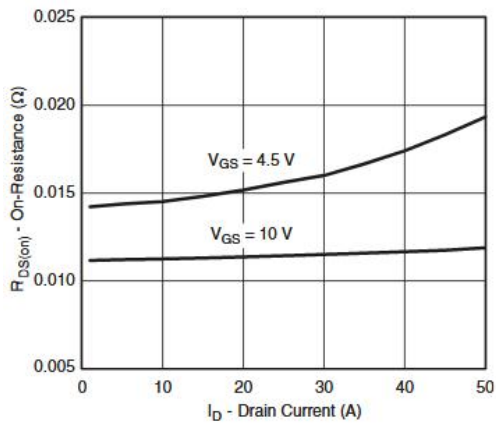
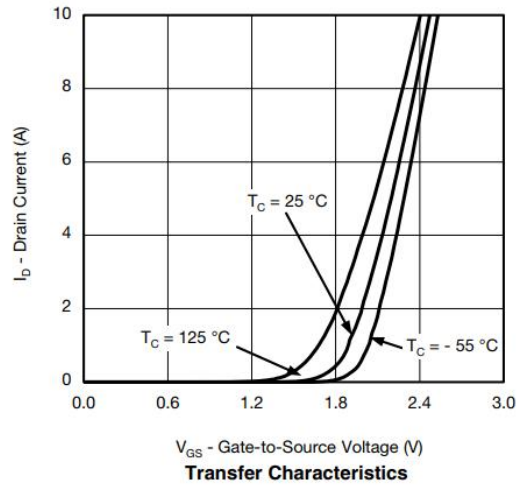
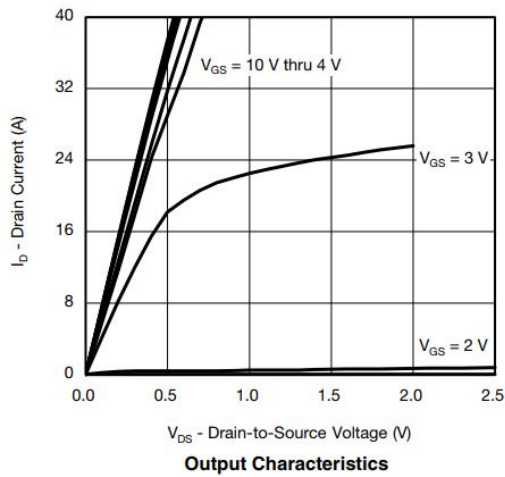

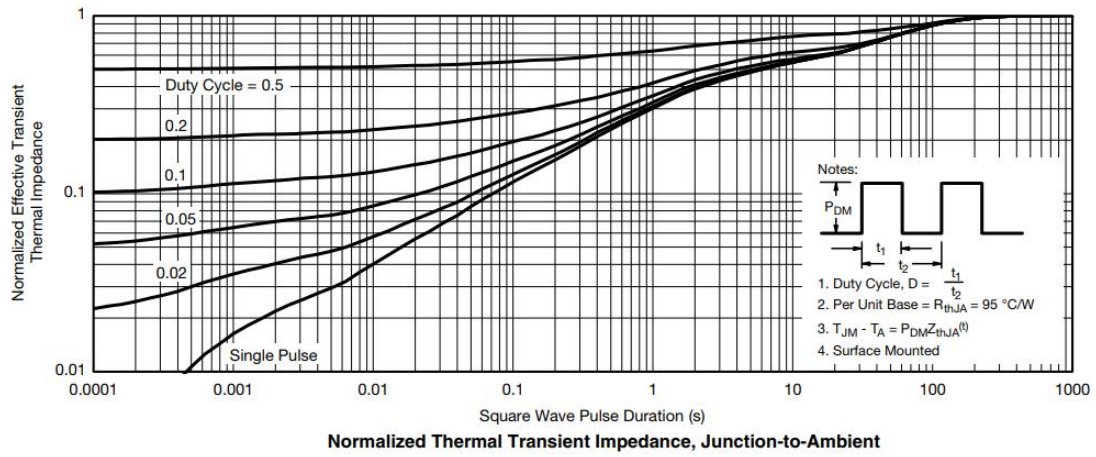

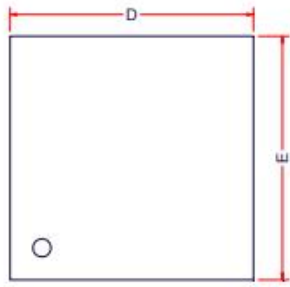
➤ Package Information

TOP VIEW

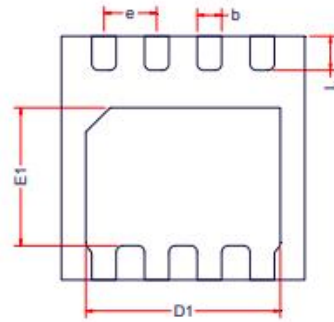

BOTTOM VIEW

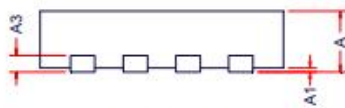

SIDE VIEW

DFN3X3-8L

Symbol	Dimensions in Millimeters		
	Min.	Typ.	Max.
A	0.70	0.75	0.80
A1	0.00	0.02	0.05
A2	0.20Ref		
D	2.90	3.00	3.10
E	2.90	3.00	3.10
D1	2.35	2.40	2.45
E1	1.65	1.70	1.75
b	0.25	0.30	0.35
e	0.65BSC		
L	0.37	0.42	0.47



DISCLAIMER

SSCSEMI RESERVES THE RIGHT TO MAKE CHANGES WITHOUT FURTHER NOTICE TO ANY PRODUCTS HEREIN TO IMPROVE RELIABILITY, FUNCTION OR DESIGN. SSCSEMI DOES NOT ASSUME ANY LIABILITY ARISING OUT OF THE APPLICATION OR USE OF ANY PRODUCT OR CIRCUIT DESCRIBED HEREIN; NEITHER DOES IT CONVEY ANY LICENCE UNDER ITS PATENT RIGHTS, NOR THE RIGHTS OF OTHERS.

THE GRAPHS PROVIDED IN THIS DOCUMENT ARE STATISTICAL SUMMARIES BASED ON A LIMITED NUMBER OF SAMPLES AND ARE PROVIDED FOR INFORMATIONAL PURPOSE ONLY. THE PERFORMANCE CHARACTERISTICS LISTED IN THEM ARE NOT TESTED OR GUARANTEED. IN SOME GRAPHS, THE DATA PRESENTED MAY BE OUTSIDE THE SPECIFIED OPERATING RANGE (E.G. OUTSIDE SPECIFIED POWER SUPPLY RANGE) AND THEREFORE OUTSIDE THE WARRANTED RANGE.

OUR PRODUCT SPECIFICATIONS ARE ONLY VALID IF OBTAINED THROUGH THE COMPANY'S OFFICIAL WEBSITE, CRM SYSTEM, OR OUR SALES PERSONNEL CHANNELS. IF CHANGES OR SPECIAL VERSIONS ARE INVOLVED, THEY MUST BE STAMPED WITH A QUALITY SEAL AND MARKED WITH A SPECIAL VERSION NUMBER TO BE VALID.